

ACTWin pro

PC Application Software



Access Control Technology

Product Overview

ACTWin pro is a PC application for use with the ACTpro family of door access controllers and can control up to 2000 doors. With its attractive and easy to use graphic interface, the database set up and user administration is simplified. The program is available in Client/Server version for multiple users or the Lite version for single user only.

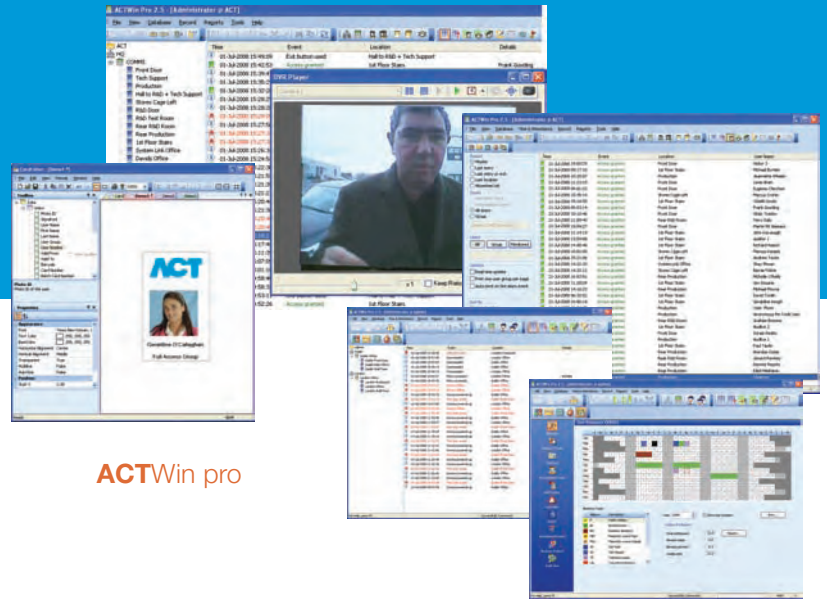

ACTWin pro

Main Features

- DVR Integration
- Email Notification
- Card Badging
- Photo-ID/Challenge
- Upload/Download
- Time & Attendance Reports
- Roll Call Reports
- Data Import/Export
- TCP/IP Support
- Control of Remote Sites
- Barcoding
- Card Encoding
- Electronic Signature (requires at least Windows 2000)
- Multi-Tenant Module available for commercial version

Other Features include:

- Multi-user access to the database (up to 10 clients, depending on your license)
 - Up to 255 local and remote sites
 - Up to 2000 doors (depending on your license)
 - Audit trails
 - Advanced database access rights for program users
 - Connect/download to all local and remote controllers at the same time
 - Microsoft SQL Server compatibility
 - Distributed client/server communications
- ACTWin pro Lite is a free of charge software for single PC / single user configuration.

* There are two versions of our software available, ACTWin pro Lite and our commercial version, ACTWin pro. ACTWin pro has additional program features not available on the Lite version.

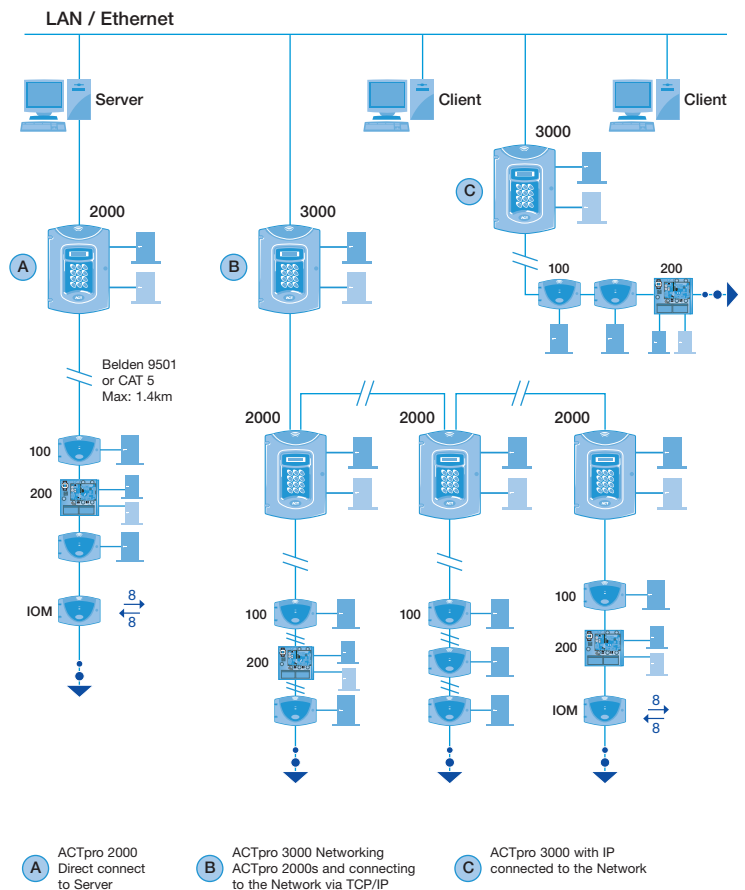

ACTWin pro Application Software



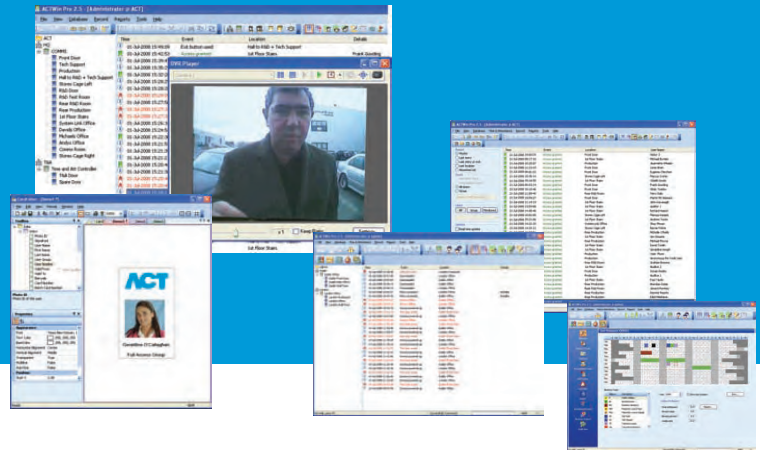

PC Specification

ACTWin pro Lite

Processor (CPU):	Pentium 4
Memory (RAM):	256 MBytes
Free Hard Disk Space:	1 GByte
Operating System:	Windows XP Windows 2000 SP4 Windows Server 2003 Windows Vista

ACTWin pro

Supported Operating System	Windows 2000, XP, 2003 Server, Vista
----------------------------	--------------------------------------

Recommended PC/OS Specification for a typical installation (20 to 60 doors):

Processor (CPU):	Pentium 4, 2.4 GHz
Memory (RAM):	512 MBytes
Free Hard Disk Space:	1 GB

Recommended Specifications for large installations (60 to 2000 doors):

Windows 2003 Server with SQL Server 2005

Comparison chart

Feature	ACTWin pro Lite	ACTWin pro
Doors	64	2000
Users	30000	30000
Groups	1000	1000
Inputs	1000	1000
Outputs	1000	1000
Challenge	Yes	Yes
DVR Integration	No	Yes
Email Notification	No	Yes
Photo-ID	Yes	Yes
T&A reports	Yes	Yes
SQL Server	Yes	Yes
User Tracking	Yes	Yes
TCP/IP	Yes	Yes
Audit Trail		Yes
Database Users	1	Unlimited
Client Server		Yes
Local and Remote Sites	3	255
Card Badging	Yes	Yes
Multi-Tenant Module Available		Yes

Ordering Information

Controller	ACTpro 3000/2000
Door Expander	ACTpro 100/200
Single channel RS485 interface	ACT Net IF-1 (requires 12v DC supply)
Four channel interface	ACT Net IF-4 (Built in PSU)



ACTpro 3000/2000 Controller



4 channel RS485 Interface



Single channel RS485 Interface

ACT Web

ACTWeb is a web based interface that allows you to manage the basic functions of the access control system, including user lists, reports and enrolled cards.

It has been developed for use in combination with the ACTWin pro PC application (2.5 or later).

ACTWin pro Web Based Interface

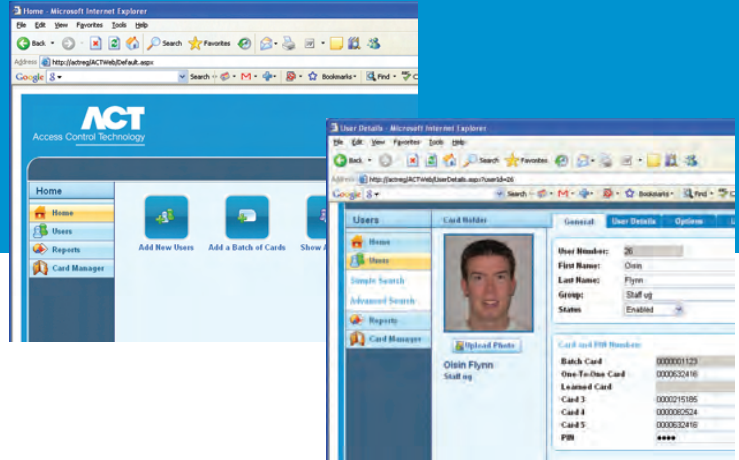

Main Features

- Web based interface
- user friendly, intuitive software
- 24 hour access to your software from Internet Explorer
- contains a comprehensive help database
- does not require the installation of any plug-ins or software
- does not require a high spec'd PC
- maintenance and software updates are done from the server and not on users workstations making it easier to deploy and manage

Main Functions

- Manage Users
- Add Users
- Reporting - see list of available reports
- Add Cards

Available Reports

- Recent Events
- Event Analysis
- User Tracking
- Time & Attendance
- User List
- Audit Trails
- Holiday Report
- Card Expiry

PC Requirements

The minimum requirements for ACTWeb are Microsoft Windows Server 2003 and Microsoft SQL Server 2005.



ACTWeb - Home Page

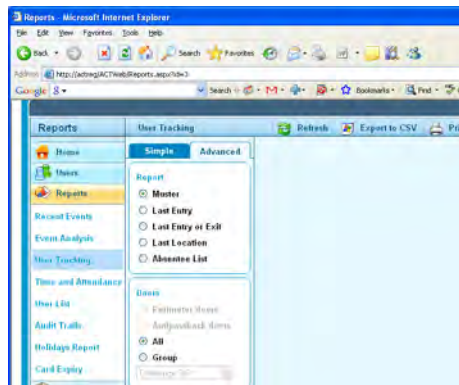

Reports - User Tracking (Advanced Search)

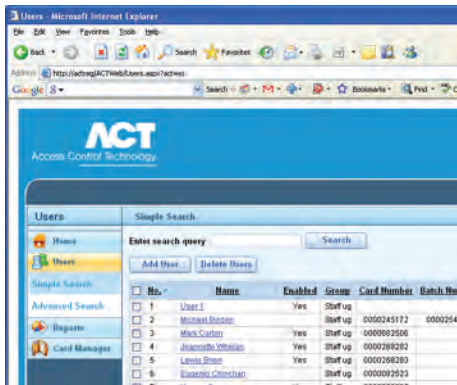

User List

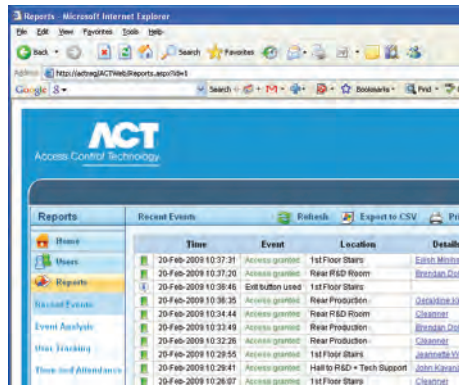

Reports - Recent Events

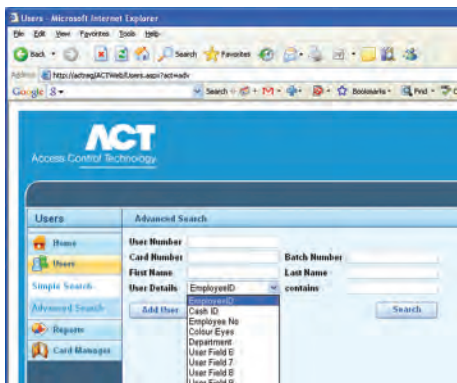

User List - Advanced Search

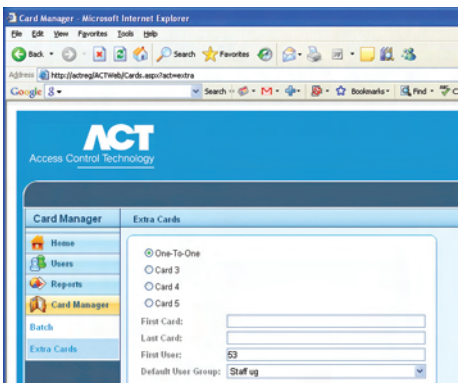

Card Manager - Add extra cards